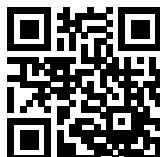

# FN3032-10-61-C20-R6

SAP Code: 823391

- Chassis mount
- 10 A EMC filter with low leakage current for Japanese market (Nano crystalline version)
- 3 Phases

[Buy article now](#)

## Family Technical Specifications

<b>Operating voltage</b>	530 / 305 VAC
<b>Operating frequency</b>	0 to 60 Hz
<b>High potential test voltage</b>	2.28 kV DC 60s, phase to phase 2.5 kV AC 60s, phase to protected earth Repetition with max. 80% of the HV test voltage
<b>Temperature range (operation and storage)</b>	-40°C to +100°C
<b>Climatic category</b>	40/100/21 (acc. IEC 60068-1)
<b>Design corresponding to</b>	UL/IEC 60939-3 CSA C22.2 No. 8-13
<b>Overvoltage category</b>	III (acc. IEC 60664-1)
<b>Rated currents</b>	10
<b>Vibration and shock</b>	According IEC60721-3-3, Level 3M4 Vibration: 10 to 55Hz, 2G, 3min, 1h each direction Shock: 20G, 11ms once each axis
<b>Altitude</b>	2000 m, current and voltage derating above
<b>Protection category</b>	IP 00 (acc. IEC 60529-1)
<b>Flammability according to</b>	UL 94 V0
<b>Pollution degree</b>	PD2 (acc. IEC60664-1)
<b>Overload capability</b>	1.5 x rated current for 1 minute once per hour
<b>Surge withstand</b>	2 kV, phase to phase (acc. to IEC 61000-4-5) 4 kV, phase to protected earth (acc. to IEC 61000-4-5)
<b>MTBF</b>	> 300'000 h
<b>Operating voltage</b>	530 / 305 VAC
<b>Operating frequency</b>	DC to 60 Hz
<b>Rated currents</b>	10
<b>Vibration and shock</b>	3M4 (acc. to IEC60721-3-3) Vibration: 10 to 55Hz, 2G, 3min, 1h each direction Shock: 20G, 11ms once each axis
<b>Flammability according to</b>	UL 94 V0
<b>Overload capability</b>	1.5 x rated current for 1 minute once per hour
<b>Surge withstand</b>	2 kV, phase to phase (acc. to IEC 61000-4-5) 4 kV, phase to protected earth (acc. to IEC 61000-4-5)
<b>MTBF</b>	> 300'000 h
<b>High potential test voltage</b>	2.28 kV DC 2s, phase to phase 2.5 kV AC 60s, phase to protected earth Repetition with max. 80% of the HV test voltage
<b>Temperature range (operation and storage)</b>	-40°C to +100°C (with derating >50°C)
<b>Climatic category</b>	40/100/21 (acc. IEC 60068-1)
<b>Design corresponding to</b>	UL/IEC 60939-3 CSA C22.2 No. 8-13
<b>Overvoltage category</b>	III (acc. IEC 60664-1)
<b>Altitude</b>	2000 m, current and voltage derating above
<b>Protection category</b>	IP 00 (acc. IEC 60529-1)
<b>Pollution degree</b>	PD2 (acc. IEC60664-1)

## Approvals & Compliances



## Features and Benefits

- A plastic housing combined with a metal ground plate achieve the lowest possible product weight without compromising EMC behaviour
- The embedded terminals from Schaffner guarantee user-friendly handling and reliable, long-lasting electrical connection
- fixed, hinged terminal covers contribute to overall safety by providing protection against unintended contact with live conductors. They are included in the standard scope of delivery without any extra cost
- Very low leakage current values make the filters suitable for grids with very tough requirements or sensitive GFCIs, and for applications which set value on safety and reliability
- FN3030 feature an ecologically conscious construction without the use of potting compound or banned substances (RoHS). Used raw materials can be easily separated at the end of the product life time for proper and environmentally safe disposal

## Typical Applications

- Electrical and electronic equipment
- Test and measurement devices
- Medical devices & Industrial automation
- Small machines

## Typical electrical schematic

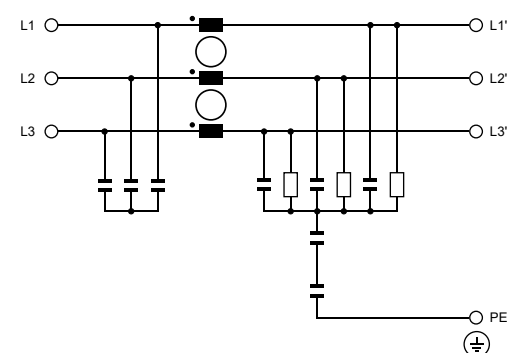

## General Specification

Voltage AC	530 (Volt)
Nominal Frequency	60
Rated Current @ambient	10
Ambient temperature [°C]	50

## Electric Specification

Leakage current (IEC60939) [mA]	4
Leakage current (Schaffner) [mA]	4
Input terminal	61 - M4 screw terminal block
Output terminal	61 - M4 screw terminal block

## Attenuation Specification

CM attenuation @ 150kHz [dB]	30 (Decibels)
DM attenuation @ 150kHz [dB]	47 (Decibels)

## Mechanic Specification

Length [mm]	128
Width [mm]	63
Height [mm]	50
Volume [cm <sup>3</sup> ]	34.354125 (Cubic Centimeter)
NetWeight [g]	500 (Gram)

## Schaffner schemes

## Dimensions